

# M15 Display

## User guide



---

## Catalog

1	About the Manual.....	2
2	<b>Technical Data(M15)</b> .....	3
1	Operations.....	4
2	<b>Menu Settings</b> .....	6
3	Appendix B (Warning message).....	8
4	Appendix C (Error message).....	9

### 1 About the Manual

- ★ This manual contains important safety, performance. Read it carefully and completely before taking the first ride.
- ★ This manual is based on the general purpose. some of the content may not be applicable due to software updates or customization.
- ★ **Important safety instructions:**  
*Do not try to connect with E-bike controller which is incompatible with this display, otherwise , will damage the display or controller.*
- ★ *Shut the battery off on time and stop the bike if some ERROR info show on screen.*
- ★ *The copyright of all the APPs related with display are belong to us, get permission from us first before running these APPs, Any damage caused by the use of illegal APPs will out of warranty.*

## 2 Technical Data(M15)

- ◆ Power: 24/36/48VDC /50 ma
- ◆ Screen: 1.54" monochrome
- ◆ Button: Transparent silicon rubber with LED Backlight
- ◆ Fix Position: Left or right of handlebar
- ◆ Communication: UART/TS232
- ◆ Material: ABS
- ◆ Ingress Protection: IP54 (dust and splash water protected)
- ◆ Customization :Valiable

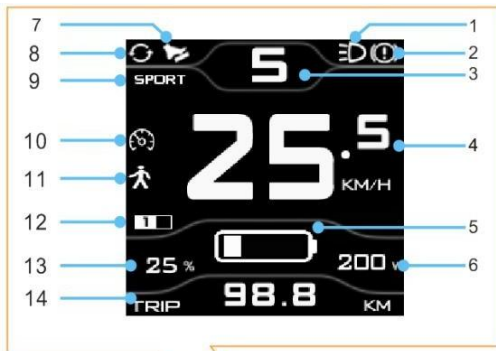
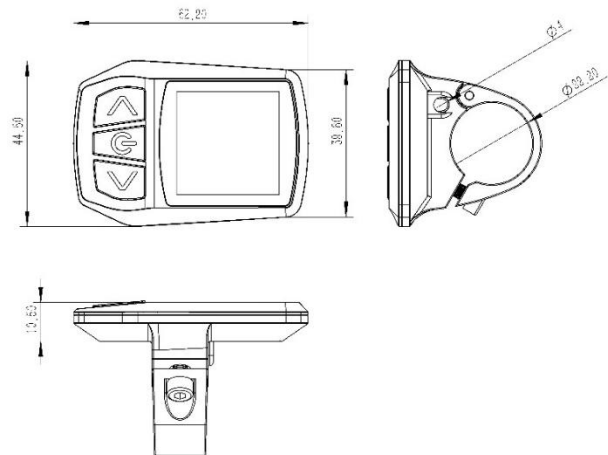

1	Light indicator	10	Cruise Indicator
2	Brake indicator	11	Walk assistance Indicator
3	Assistance level indicator	12	Double battery system indicator
4	Speed	13	Drive value
5	Battery Indicator	14	Information indicator
6	Power Indicator	15	UP button
7	PAS indicator	16	POWER button
8	Throttle indicator	17	DOWN button
9	Ride mode indicator		

---

## Power on & off

--Long press **G** button with 3 seconds ; user have to input password after power on if system was activated with password protecting function.

## light on & off

--Long press **A** button with 3 seconds ,there has 3 options for light on or off .

## Switching Assistance level

--Short press **A** button to increase assistance level or **V** button to decrease assistance level . the maximum assistance level can be set from 1 to 8 . usually more bigger level means more powerful and more speed;

--**Zero Level** ,The electric assistance switched off  
-- Special level **A,C,R** Level should be activated by menu options.

--**Auto Level** ,System will automatically adjust the power and motor speed according to the bike speed .

--**C Level** -Strong power at C level when use pedal sensor up-hill.

--**R Level** ,Motor will run backwards.

## Walk assistance

--Walk assistance can make it easier for you to push the bike. The assisting speed can reach a maximum of 6km/h , **Using the walk assistance function is only recommended when pushing the bike and make sure bike's rim was touched with ground.**

## Cruise

--Long press **V** button to activate Cruise function when bike speed is more than activated speed and electric assisting is on ,

--Pull brake or move the pedal or pull the throttle or press any key on display will cancel cruise

**Caution: There is risk of accident if you didn't concentrate on riding.**

## Switching riding mode

--Three riding mode is ,ECO ,CITY ,SPORT ,you can select desired mode by both long press **G** and **A** button.

--ECO : Effective assistance at maximum efficiency for maximum cruising range.

--CITY : Uniform assistance with long cruising range.

--SPORT: Powerful assistance for sporty off-road riding, as well as for urban traffic.



## Clear Trip , Max speed , AVG speed

--These information was shown at bottom of screen ,TRIP and MAX SPEED , AVG SPEED can be cleared by long pressing **G** button and **V** button with 3 seconds;

## Bike information



--Short press  button can switch the bike info show at bottom of screen , bike info include TRIP , TRIP TIME , ODO ,MAX SPEED , AVG SPEED , TEST , INFO.

## INFO

-- Press  bottom when the INFO show on information indicator and short press  button can show different interface below.

### --Product information

Show Version number, model of the product , service distance and Password.

Press  bottom or  bottom , it can change the brightness of the screen.

### --Presentation mode

Once enter this interface ,it can help you fully know how it works.

## TEST

-- At this interface , you can check the status of all the components with details. which was connected with system .

--Pressing  bottom when the TEST show on information indicator,

-- short pressing  button can repeatedly switch such interface below

### --Realtime Voltage and current and power

CONTROLLER		
VOLTAGE	36.5	V
CURRENT	0.0	A
POWER	0.0	W

### -- Motor information

Notice: you also can get correct motor reduction ratio when an unknow motor come to you.

MOTOR		
SPEED	0	RPM
REDUCTION RATIO	4.3	
HALL		AVAILABLE

### -- Battery information

BATTERY		
TOTAL CONSUME	0.0	AH
SINGLE CONSUME	0.0	AH
TIMER	0	MIN

### -- Pedal sensor status and throttle status

THR & PAS		
THROTTLE	0.0	V
PAS SPEED	0.0	RPM
DRIVE VALUE	0	%

### -- Brake ,speed and shift sensor status

SENSOR		
BRAKE		OFF
SPEED		OFF
SHIFT		OFF

---

## 4 Menu Settings

This is a full menu sets for M15 display , not all of the menu item will be visible for end user because some settings is only for some advance applications ,sometimes, maybe you can't modify set because you didn't get permissions from supplier , all menu items show with letters , it can help you to understand the meaning of each item easily, if you do not fully understand it , **DON NOT CHANGE SETS ,incorrect set may make system failure.**

Long press **G** button for 3 seconds to start up, release **G** button when the startup interface appears, and immediately press **G** button and **A** button together to enter the password input interface.

- Password need be imputed if menu password protection option was activated.
- incorrect setting may cause bicycle can't work or make components failure.
- Maybe you can't modify settings because you don't have modify permissions;
- Some menu item may will be invisible.

### a) Access settings menu

- Setting menu overview

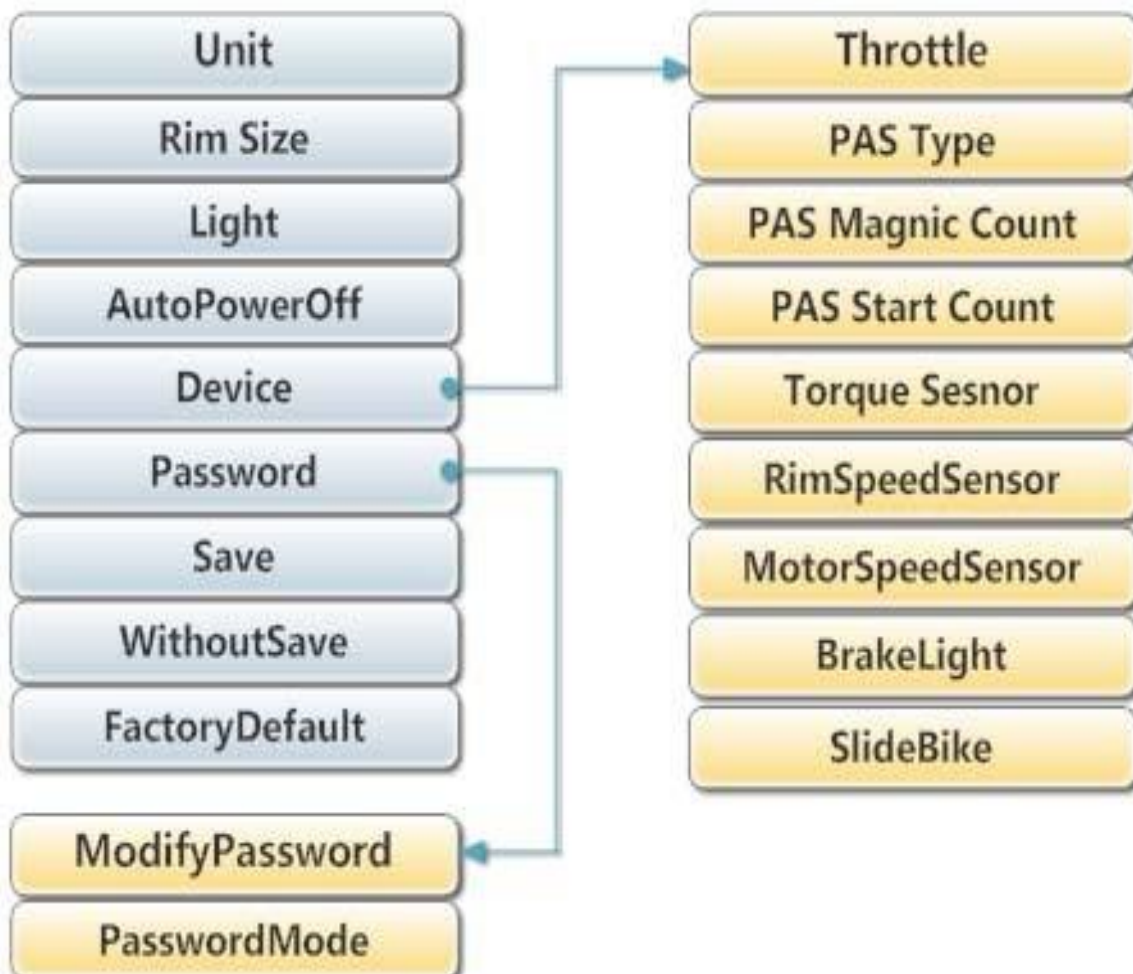

Menu Items	Instructions	Range of values
Unit	Speed mileage display unit	Metric, British
Rim Size	Wheel diameter	6inch-30Inch
Light	Headlight control	Manual - Manually control the headlight switch Auto - Automatic control (automatic control of light sensor) On - Always on when the vehicle is powered on
AutoPowerOff	Automatic shutdown time	3-15 minutes, when the vehicle is stationary beyond the set time, the automatic shutdown time
Device	Attachment Settings	See below
Password	Factory default user password: 1234	Change the user password, and password protection mode Non - No password protection function, PowerOn - boot password Menu - Password is required to access the Settings menu only (Note: Advanced password is not modifiable for users)
Save	Save Settings	Settings are not effective until the meter is turned back on after saving
WithoutSave	Discard this modification	
Factory Default	Restore factory default parameters	Modded type of meter, this menu is not visible
Throttle	Turn the knob on or off	Disable- Turns off, Enable - Turns on
PAS Type	PAS Type selection	Disable- To close, Low,High - no direction discriminant type PAS Auto - With directional discriminant type PAS
PAS MagnicCount	PAS magniccount	5-64
PAS Start Count	Number of PAS start magnets	1-12
TorqueSensor	Torque sensor function	Disable- Off, Enable- On
RimSpeedSensor	Wheel speed sensor magnetic steel number	0-12, with 0- indicating no equipment
MotorSpeedSensor	Motor built-in speed sensor magnetic steel number	0-36, with 0- indicating no equipment
BrakeLight	Brake taillight type and function	Disable - Off On/Off - three-wire brake taillights PWM - two-wire brake taillights
SlideBike	Scooter features	Disable- off, Enable - on

## b) Access advanced settings menu

- To start the advanced settings, press and hold the **▲** and **▼** bottom simultaneously after entering the user setting menu. Enter the default advanced password (1234)

- Advanced menu setting overview

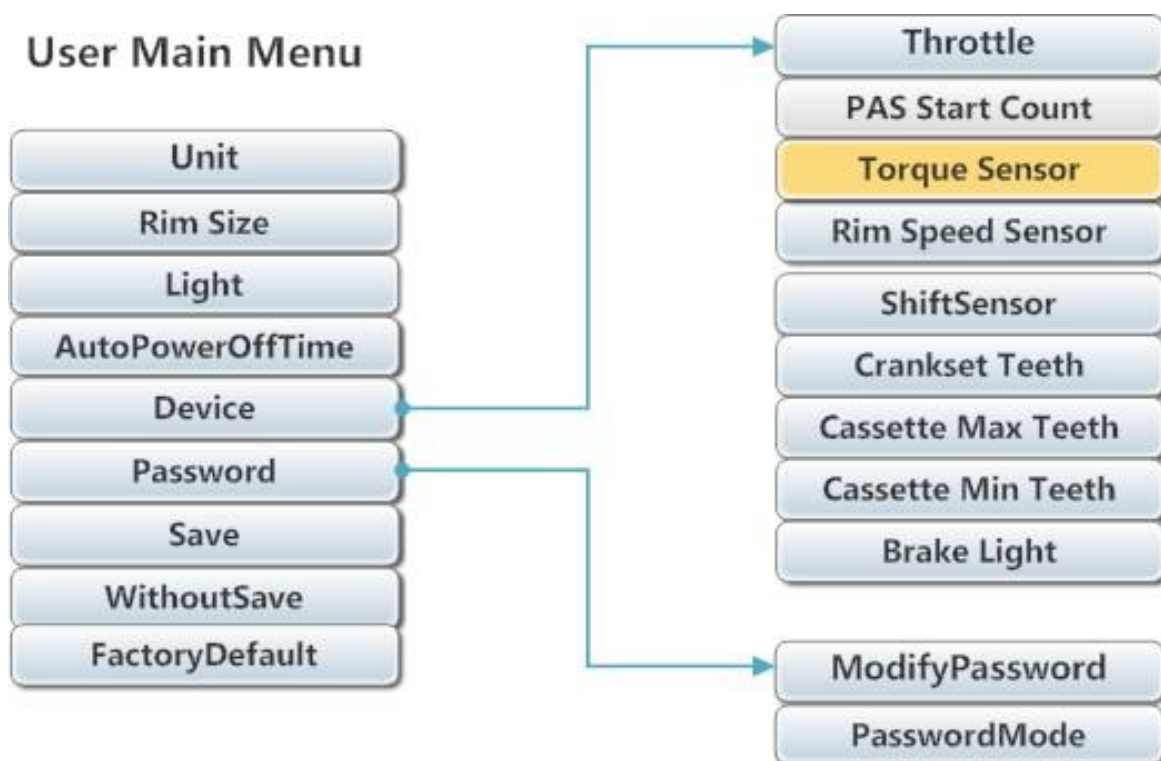



## ➤ Application

Menu Items	Instructions	Value range
Unit	Speed mileage display unit	Metric, British
Rim Size	Wheel diameter	6inch-30Inch
Light	Headlight control	Manual - Manual control Auto - Automatic control (hardware support required) On - Always on when the vehicle is powered on
AutoPowerOff	Automatic shutdown time	3 minutes -15 minutes, when the vehicle is stationary beyond the set time, automatic shutdown time
Device	Attachment setting	See below
Password	Factory default user password: 1234	Change the user password, and password protection mode Non - No password function, PowerOn - boot password Menu - Password is required to access the Settings menu only (Note: Advanced password is not modifiable for users)
Save	Save Settings	Settings are not effective until the meter is turned back on after saving
WithoutSave	Discard this modification	
Menu item	Instructions	Range of values
Throttle	Turn the knob on or off	Disable , Enable
PAS Startup Count	Number of PAS startup magnets	1-6
RimSpeedSensor	Wheel speed sensor magnetic steel number	0-30, with 0- indicating no equipment
ShiftSensor	Shift sensor on or off	Disable , Enable
Crankset Teeth	Crankset teeth	
Cassette Max Teeth	Maximum number of teeth for rear-shift	
Cassette Min Teeth	Minimum number of teeth for rear-shifting	
Brake Light	Rear brake light function on off	Disable , Enable

## ➤ Speed&Power (Gear speed and power limit definition)

Specify the speed and current limits for each gear, with the current limit being a percentage of the maximum allowable working current

## ➤ Battery

The user can redefine the power meter of the battery in this interface by pressing and holding the **▲** and **▼** bottom at the same time. The OCV mode will be used for power measurement.

Note: To enter the definition of the electric meter, long press the **▲** and **▼** bottom. For more information, please refer to 《 section ② Definition of the battery electric meter 》

Menu	Description	Ranges
Type	Battery type	Customize -36V- 48V
StandardVoltage	nominal voltage	20V-60V
LowCutVoltage	Undervoltage value	15.0V – 55.0V

## ➤ Controller

Menu	Description	Ranges
MaxCurrentECO	The maximum current allowed in ECO mode	5a- 50a , The maximum current must not be greater than the rated current of the controller
MaxCurrentECITY	The maximum current allowed in CITY mode	5a- 50a ,The maximum current must not be greater than the rated current of the controller
MaxCurrentESPORT	The maximum current allowed in SPORT mode	5a- 50a , The maximum current must not be greater than the rated current of the controller

## ➤ Motor

To enter the FOC special parameter setting, press and hold the **▲** and **▼** keys simultaneously when the controller is in FOC mode. For more information, please refer to 《 section ① FOC vector control special setting 》

Menu	Description	Ranges
Gear	Motor gear	GearLess, Gear
PolePairs		
ReductionRatio		
AngleOffest	Hall installation angle error	-30° -30°
MotorConstant	Peak torque/square	After setting the motor

	root of continuous power	parameters, the user can run the TEST Motor function to make the motor rotate. The value of the rotation speed can be obtained in this interface
StartMinVoltage%	Start initial loading voltage	0%-50% ( % of battery voltage )
StartMaxVoltage%	Start maximum loading voltage	0%-70% ( % of battery voltage )
StartSpeed(rpm)	Start initial speed	1-60rpm
StartMaxCount	The maximum frequency of commutations for the BLDC motor startup process	1-240
CommuteTable	motor commutation table	
Test Motor	Motor testing	The motor must be tested in a suspended state with the wheels off the ground. This is to ensure safety and to obtain accurate results. The real reduction ratio and motor constant can also be obtained by applying this function

## ➤ PAS

Menu	Description	Ranges
Type	PAS type	Disable - disable PAS function Low - Non-directional discrimination type 1 High - Non-directional discrimination type 2 Auto - With irection discrimination type PAS
MagnicCount	PAS magnets number	3-64

StartupCount	PAS starter magnets number	1-6
FilterCount	Smooth speed	1-3
KeepTime(ms)",		200ms-1000ms
MaxSpeed(rpm)	Maximum speed	60rpm – 200rpm
ControlMode	Speed control mode  Under PedalSpeed mode,  Bicycle speed = PAS speed x maximum wheel speed / maximum PAS speed	MaxBikeSpeed – maximum gear speed limit  LevelSpeed - gear speed limit  PedalSpeed1 -PAS rotate speed corresponds to bicycle speed, maximum speed limit  PedalSpeed2 -PAS speed corresponds to bicycle speed, maximum speed limit

## ➤ Throttle

Menu	Description	Ranges
Activate	Turn the throttle on or off	Disable,Enable
StartupVol (mv)	The minimum voltage to start the throttle	800mv-2000mv
ControlMode	Speed control mode	0-12, Note: the throttle operation and speed limit are associated with the PAS working status. The speed limit is shown in the table below:

(throttle operation and speed limit mode table)

Mode	PAS not working	After PAS work
0	Null not working	6kmh
1	Null not working	Level (gear speed)

2	Null not working	Ful (maximum gear speed)
3	6kmh	6kmh
4	6Kmh	Lelvel (gear speed)
5	6Kmh	Full (maximum gear speed)
6	Level gear speed	Level (gear speed)
7	Level gear speed	Full (maximum gear speed)
8	Full (Level gear speed)	Full (maximum gear speed)
9	6kmh	Full2 (maximum gear speed)
10	Level gear speed	Full2 (maximum gear speed)
11	Full (maximum gear speed)	Full(maximum gear speed)
12	Scooter	Scooter mode, no speed limit

## ➤ Torque Sensor

Menu	Description	Ranges
Activate	Torque sensor on or off	Disable, Enable
Mode	Operating mode	<p>Sensitive – when Net torque output voltage &gt; StartupNetVol, torques sensor is activated</p> <p>Safe – when Net torque output voltage &gt; StartupNetVol, and start pedaling, the torque sensor is activated</p>
ZeroVol(mv)	Zero point voltage	100mv- 2000mv

MaxVol(mv)	Output voltage	1000mv- 3300mv
StartupNetVol(mv)	Net starting voltage (note: starting voltage =current power supply - zero point voltage)	200mv- 2000mv
KeepAngle(Deg)	The output keeps the pedal angle constant, and the output stability can be adjusted	0-180°
MinOutCurrent(a)	The minimum current bias  The torque signal is proportional to the motor phase current	0-10a
Filter	Torque sensor smooth signal	0-10
StengthValue	Assist strength = electric power/manpower	0-10

## ➤ TemperatureSensor

Menu	Description	Ranges
Activate(CTL)	Activate controller temperature sensor	Disable,Enable
OverTemp(CTL)	Current limiting mode in over-temperature state	Skip – unlimited power  30% Power -The motor is limited to 30% power  after overheating  50% Power -The motor is limited to 70% power after overheating

		70% Power -The motor is limited to 70% power after overheating
MinTemp(CTL)	Overheating start point	50°-80°
MaxTemp(CTL)	Maximum overtemperature end point	60°-100°
Activate(MOT)	Activate motor temperature sensor	Disable,Enable
OverTemp(MOT)	Current limit mode when overheated	Skip – unlimited power 30% Power -The motor is limited to 30% power after overheating 50% Power -The motor is limited to 70% power after overheating 70% Power -The motor is limited to 70% power after overheating
MinTemp(MOT)	Overheating start point	50°- 100°
MinTemp(MOT)	Maximum overtemperature end point	60°-120°

Notice: The motor temperature sensor is not included in the standard configuration. Please contact the seller for more information

## ➤ Restore Factory Settings

All data and settings on the display will be deleted and reset to the factory defaults.



Process: Main menu setting - Factory Default

### ① FOC vector control special setting

The display shows the controller's working mode. If the controller is in FOC mode, to enter the FOC parameter setting,

#### FOC Menu



long press the  and  bottom in the motor setting menu.

Menu	Description
Resistance(mohm)	Motor internal resistance, test by LCR, unit: milliohm
Inductance(uH)	Motor inductance, test by LCR, unit: : microhenry
SpeedKp	Speed PID Kp value (5-200)
SpeedKi	Speed PID Kp value (1-100)
Speed Filter	Speed feedback smoothing value (6-120)
CurrentKp	Current loop PID Kp value (20-5000)
CurrentKi	Current loop PID Kp value (1-500)
Auto CurrentPID	Determine the Kp and Ki values of the current loop PID automatically based on the motor's internal resistance and inductance
FluxWeakVoltage	The field-weakening speed-up function is activated in the battery voltage range ( 90% to 98% )
FluxWeakCurrent	<p>Weakening field speed expansion maximum current (a)</p> <p>0a-10a (0A means no field weakening function)</p> <p>Field weakening is a special function that not all FOC controllers have. <b><u>It can cause demagnetization of the motor</u></b>, so please consult the</p>



---

	seller before using it	
--	------------------------	--

② Definition of the battery electric meter

The system has a standard power definition table for 36V and 48V batteries. When using a non-standard battery (such as a 54V battery) or if the battery's discharge characteristics differ from the standard, the user can measure the battery's OCV (open circuit voltage) curve to set the voltage value







**Battery Capacity**





- Capacity=0%
- Capacity=20%
- Capacity=40%
- Capacity=60%
- Capacity=80%
- Capacity=100%

Menu	Description
Capacity=0%	Power =The open circuit voltage value at zero current
Capacity=20%	Power =The open circuit voltage of a battery at 20% state of charge
Capacity=40%	Power =The open circuit voltage of a battery at 40% state of charge
Capacity=60%	Power =The open circuit voltage of a battery at 60% state of charge
Capacity=80%	Power =The open circuit voltage of a battery at 80% state of charge
Capacity=100%	Power =The voltage of a fully charged battery

## 5 Error messages

Don't not use bike and try to shut the battery power off if errors were happened, **DO NOT TRY TO REPAIR IT BY YOURSELF** , send your bike to your service station , otherwise may result in serious injury.

<p><b>WARNING</b></p> <p>Protocol Mismatch</p> 	<p>Communication encryption index number and controller inconsistency</p> <p>Solution:</p> <ol style="list-style-type: none"> <li>1. Purchase a controller from the original system supplier</li> <li>2. Purchase a controller with the same encrypted index number</li> </ol>	<p><b>WARNING</b></p> <p>Communication Interrupted</p> 	<p>The communication connection between the instrument and the control is interrupted</p> <p>Solution: Check the connection line between the instrument and the controller to check whether the controller is damaged</p>
<p><b>WARNING</b></p> <p>Controller memory Fail</p> 	<p>Controller memory hardware failure or control memory save parameter verification failure</p> <p>Workaround: Replace the controller</p>	<p><b>WARNING</b></p> <p>Gallop Throttle Fail</p> 	<p>throttle failure</p> <p>Solution: Replace the throttle</p>
<p><b>WARNING</b></p> <p>Controller Mosfet Fail</p> 	<p>The controller MOS tube is damaged</p> <p>Solution: Replace the controller</p> <p><b>Important note: Once this fault occurs, please turn off the battery power immediately, otherwise it may cause battery damage, and even have the risk of fire</b></p>	<p><b>WARNING</b></p> <p>Motor Blocked</p> 	<p>Motor Blocked</p> <p>Solutions:</p> <ol style="list-style-type: none"> <li>1. Reboot</li> <li>2. Reset the phase parameters</li> <li>3. Replace the motor</li> </ol>

<p><b>WARNING</b></p> <p>Speed Sensor Fail</p> 	<p>Speed sensor fail</p> <p>Solution:</p> <ol style="list-style-type: none"> <li>1. Check that the speed sensor is installed correctly</li> <li>2. Replace the sensor</li> </ol>	<p><b>WARNING</b></p> <p>Motor Hall Fail</p> 	<p>Motor Hall damage</p> <p>Solution: Replace the motor</p>
<p><b>WARNING</b></p> <p>Controller OverTemp</p> 	<p>Controller over-temperature</p> <p>Solution: stop riding or reduce the power of the ride</p>	<p><b>WARNING</b></p> <p>Motor OverTemp</p> 	<p>Motor over-temperature</p> <p>Solution: stop riding or reduce the power of the ride</p>